

DT-3+1

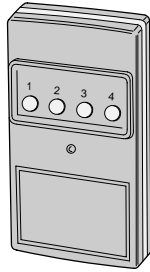

DIGITAL TRANSMITTER

Code Setting Instructions



Linear®

(800) 421-1587 • www.linearcorp.com

STEP 2 Setting Code Switches. The coding switches have eight keys numbered 1-8. To set coding switch "A", select any combination of ON or OFF positions for switch keys numbered 3-8. Use a paper clip or other pointed object (except a pencil or pen) to set the keys. To set coding switch "B", select any combination of ON or OFF positions for switch keys numbered 1-8.

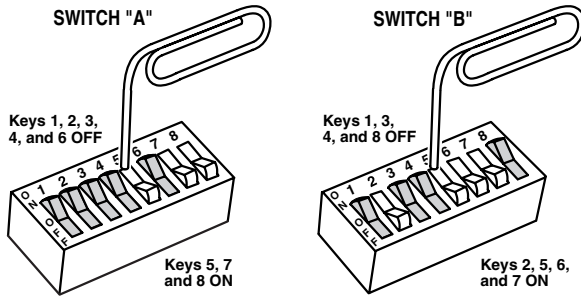

CAUTION: IT IS NOT ADVISABLE TO SET A CODE WITH ALL KEYS ON, OFF, OR ALTERNATING ON AND OFF. THESE CODES CAN EASILY BE DUPLICATED.

STEP 4 Test the equipment. Connect the receiver(s) to the operators as described in the receiver's installation instructions. **Be sure the door/gate area is clear.** Activate the transmitter and verify that the receiver triggers the operator. Check that the correct button on the DT-3+1 activates the desired operator.

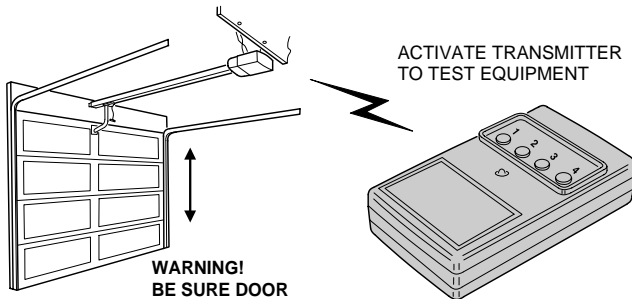

WARNING!
BE SURE DOOR AREA IS CLEAR OF OBSTRUCTIONS

DESCRIPTION

The Delta-3 DT-3+1 is a hand-held four-channel transmitter with a three-channel section plus an individual one-channel section. It is designed so that channel 1 may have a system code independent of the other three channels. This transmitter operating in conjunction with four single-channel receivers, or one multi-channel receiver, can perform a variety of remote switching tasks. The DT-3+1 has 2 digital encoders (switch A, and switch B). Coding switch "A" is designed for use with private multiple garage door openers, activated by push buttons 2, 3, and 4. Coding switch "B" under the back cover is designed for use with less frequently changed codes, such as a community access gate that can be activated by push button 1.

NOTE: The transmitter transmits continuously with the button pressed. The red indicator lights during transmission to indicate battery condition. Should it fail to illuminate, it is recommended that you replace the 9-volt battery.

STEP 3A Code Setting for Four Single-Channel Receivers. Set keys 3-8 of receivers 2, 3, and 4 to match keys 3-8 of switch "A". Set keys as follows:

- Receiver 1 - Set all eight keys to match switch "B", activates from button 1
- Receiver 2 - Set Key 1 and 2 OFF, match keys 3-8, activates from button 2
- Receiver 3 - Set Key 1 ON, Key 2 OFF, match keys 3-8, activates from button 3
- Receiver 4 - Set Key 1 OFF, Key 2 ON, match keys 3-8, activates from button 4

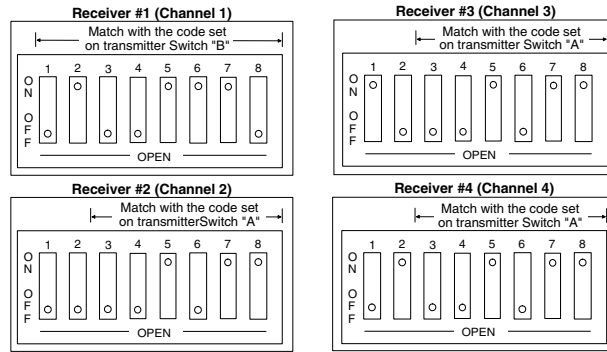

STEP 1 Locate coding switch. There are two digital coding switches in the DT-3+1 transmitter. Code switch "A" is exposed by removing the battery access cover by inserting your thumbnail or small screwdriver under either of the two slots at the edge of the case. To access switch "B" remove the battery and remove the rear half of the case by gently pulling down and back on the battery end of the rear case. (CAUTION: the white plastic push buttons rest freely in case front and may fall out if care is not exercised.)

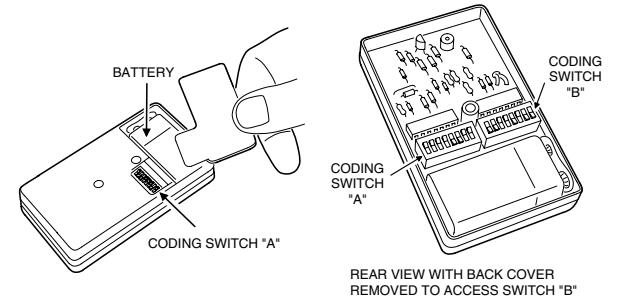

STEP 3B Code Setting for Four-Channel Receiver. Set coding switch keys 3-8 of receiver to match keys 3-8 of coding switch "A" of the DT-3+1. Matching these keys completes the coding procedure required to activate the first THREE channels of the receiver. The receiver keys 1 and 2 do not have to be set. Their functions are preprogrammed to access channels 1-4. Receiver channels are activated as follows:

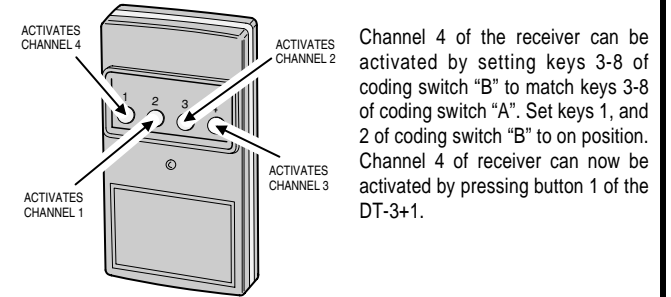

Channel 4 of the receiver can be activated by setting keys 3-8 of coding switch "B" to match keys 3-8 of coding switch "A". Set keys 1, and 2 of coding switch "B" to on position. Channel 4 of receiver can now be activated by pressing button 1 of the DT-3+1.

BATTERY REPLACEMENT

The battery should last 12 to 18 months with normal use. The red LED on the face of the transmitter will glow when the unit is activated. When the red LED lights dimly, or not at all when transmitting, the battery needs to be replaced. Remove the battery access door to change the battery. Any type of 9-volt battery can be used.

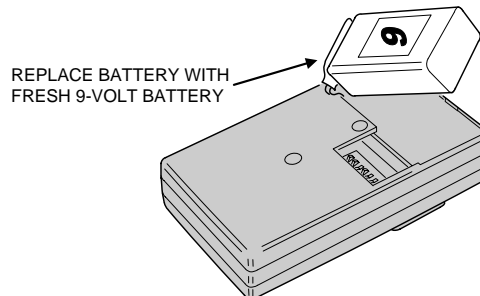

LINEAR LIMITED WARRANTY

This product is warranted to the consumer against defects in material and workmanship for one year from the date of purchase. This warranty applies to first retail buyers of new devices. Warrantor will repair, or at its option, replace, any device it finds that requires service under this warranty, and will return the repaired or replaced device to the consumer at the warrantor's cost. For warranty service and shipping instructions contact warrantor at the address shown below. Devices must be sent to warrantor for service at owner's expense. The remedies provided by this warranty are exclusive. Implied warranties under state law are to the one year period of this written warranty. Some states do not allow limitations on how long an implied warranty lasts, so the above limitation may not apply to you. In order to be protected by this warranty, save your proof of purchase and send copy with equipment should repair be required. This warranty gives you specific legal rights, and you may also have other rights which vary from state to state.

All products returned for warranty service require a Return Product Authorization Number (RPA#). Contact Linear Technical Services at 1-800-421-1587 for an RPA# and other important details.

IMPORTANT !!!

Linear radio controls provide a reliable communications link and fill an important need in portable wireless signaling. However, there are some limitations which must be observed.

- * For U.S. installations only: The radios are required to comply with FCC Rules and Regulations as Part 15 devices. As such, they have limited transmitter power and therefore limited range.
- * A receiver cannot respond to more than one transmitted signal at a time and may be blocked by radio signals that occur on or near their operating frequencies, regardless of code settings.
- * Changes or modifications to the device may void FCC compliance.
- * Infrequently used radio links should be tested regularly to protect against undetected interference or fault.
- * A general knowledge of radio and its vagaries should be gained prior to acting as a wholesale distributor or dealer, and these facts should be communicated to the ultimate users.

This device complies with FCC Rules Part 15. Operation is subject to the following two conditions: (1) This device may not cause harmful interference and (2) this device must accept any interference received, including interference that may cause undesired operation.